

Ocelové obvodové profily

Profil obvodový

kod	s	délka	A	B	C	D	E	hmotnost	materiál
210005	2,0	6000	81	40	27	15	28	2,78 kg/m	ocel
210010	2,0	6000	84	40	27	18	22	2,78 kg/m	ocel
210020	2,5	6150	108	40	30	21	25	4,03 kg/m	ocel
210022	2,5	6500	108	40	30	21	25	4,03 kg/m	ocel
210025	3,0	6150	111	40	30	24	27	5,01 kg/m	ocel
210040	3,0	6150	116	40	39	37	30	5,38 kg/m	ocel

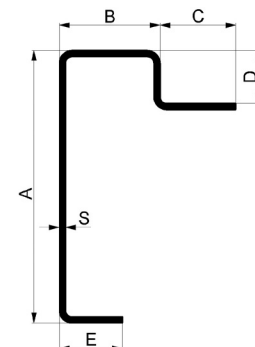

Profil obvodový

kod	s	délka	A	B	C	D	F	hmotnost	materiál
210070	3,0	6300	160	40	40	27	45	6,8 kg/m	ocel
210075	3,0	7000	160	40	40	27	45	6,8 kg/m	ocel
210080	3,0	7500	160	40	40	27	45	6,8 kg/m	ocel
210085	3,0	8000	160	40	40	27	45	6,8 kg/m	ocel

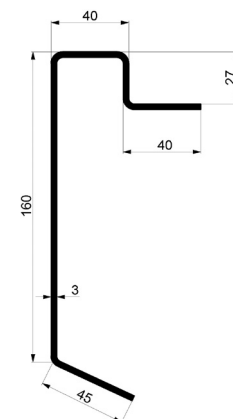

210097

Profil obvodový ocel,
s drážkou pro oka,
100 x 15 x 2 mm
25,2 kg, ocel, 6500 mm

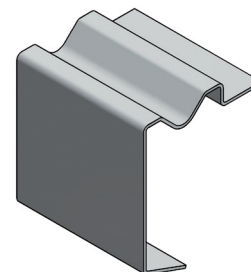
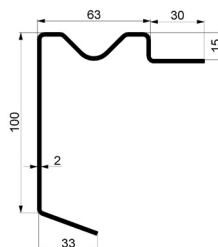

210100

Profil obvodový ocel
s drážkou pro oka,
92 x 17 x 2 mm,
20,6 kg, ocel, 6000 mm

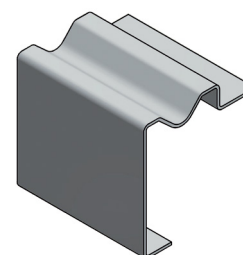
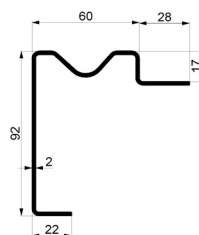

210103

Profil obvodový ocel
s drážkou pro oka,
109 x 21 x 3 mm,
39 kg, ocel, 6500 mm

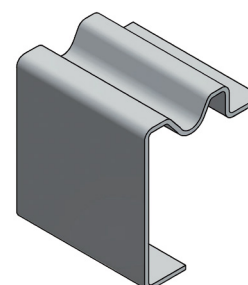
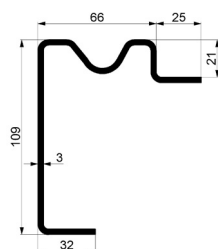

Ocelové obvodové profily

210113

Profil obvodový NEW
160 x 27 x 4 mm, 7500 mm,
s otvory na hák popruhu o 30 mm po 100 mm
materiál S355MC
75 kg, ocel, 7500 mm

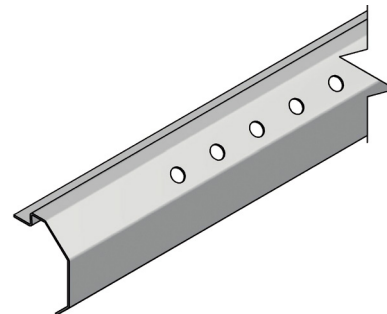
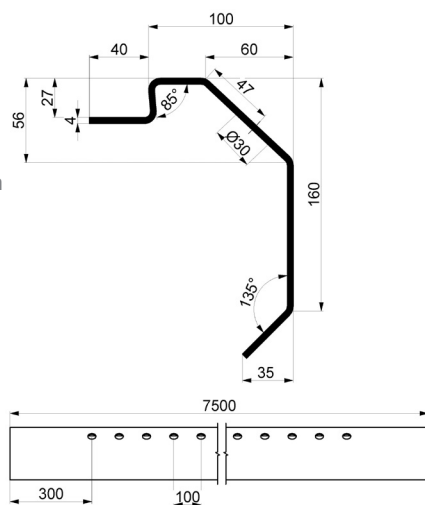

210030

Profil obvodový ocel pro oko
109 x 21 x 3mm
36,1 kg, ocel, 6500 mm

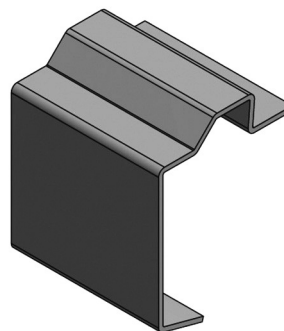
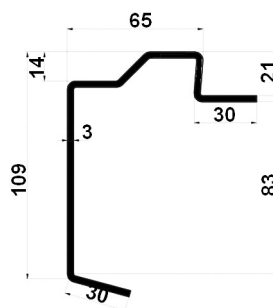

210032

Profil obvodový ocel pro oko
109 x 21 x 3mm
41,6 kg, ocel, 7500 mm

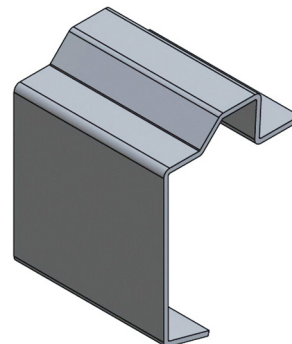
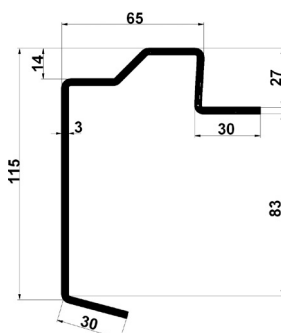

210035

Profil obvodový ocel pro oko
115 x 27 x 3mm
35,9 kg, ocel, 6150 mm

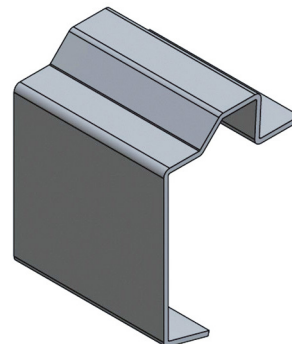
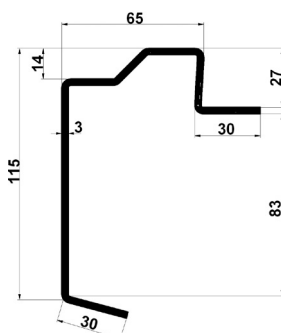

210037

Profil obvodový ocel pro oko
115 x 27 x 3mm
43,7 kg, ocel, 7500 mm

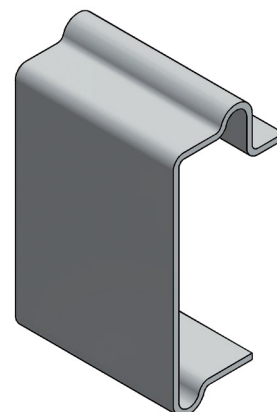
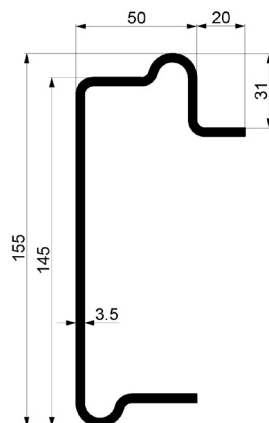

210090

Profil obvodový ocel
145x31x3,5 mm
63,3 kg, ocel, 8000 mm

